

MEKANIKA

3 AXIS CNC MILLING MACHINE

EVO

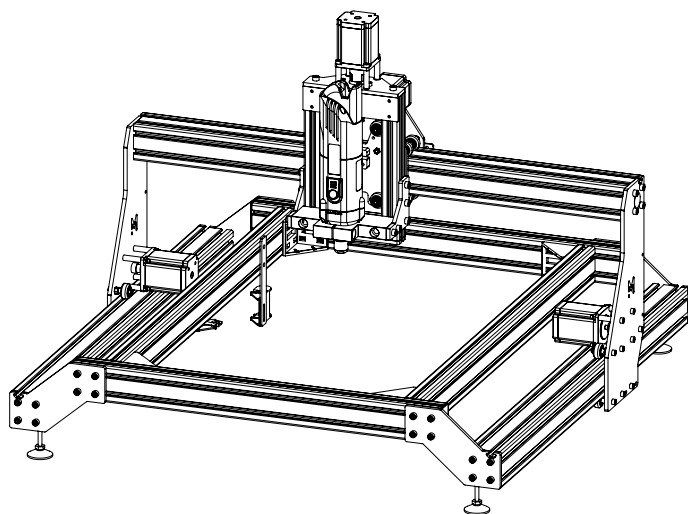

KIT CONTENT

EVO

BOX 1/2 : Main box

The main box contains the **control unit**, the **interface unit** and **four smaller boxes** :

- ↳ Mechanical Elements Box
- ↳ Electronic Components Box
- ↳ Spindle Box
- ↳ Specific Parts Box

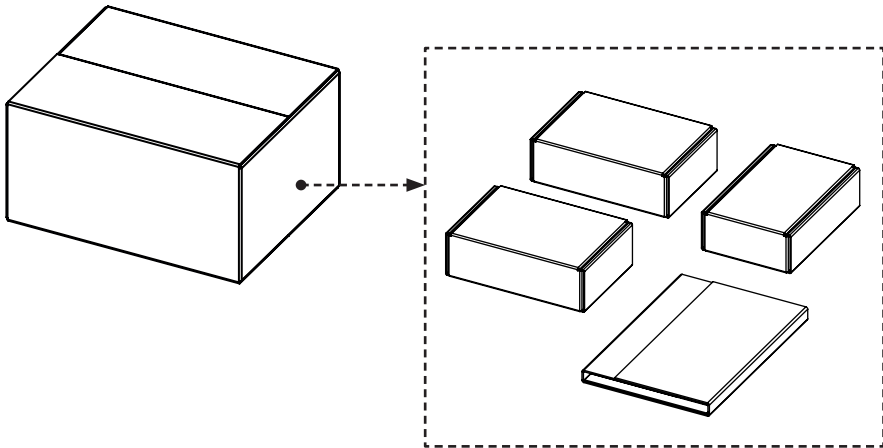

BOX 2/2 : Structure Box

The structure box contains the **aluminium profiles** and the **cable chains**.

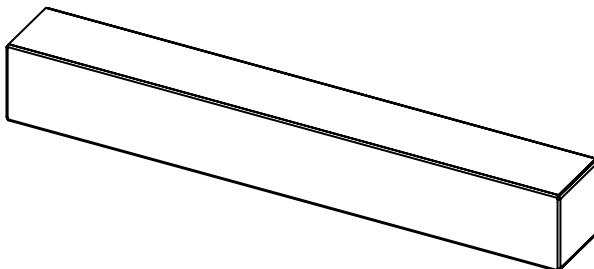







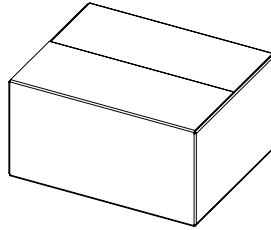

KIT CONTENT

EVO

BOX 1/2

↳ Main box



ITEM	NAME	TYPE	S	M	L
	<i>Specific Parts Box</i>	-		1	
	<i>Spindle Box</i>	-		1	
	<i>Mechanical Elements Box</i>	-		1	
	<i>Electronic Components Box</i>	-		1	
	<i>Control Unit</i>	-		1	
	<i>Control Interface</i>	-		1	
	<i>First G-code Panel 20x20cm</i>	12mm		1	

KIT CONTENT









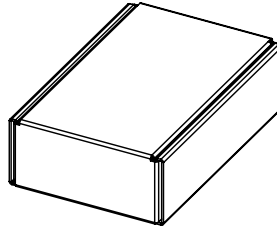

EVO

















BOX 1/2



















↳ Main Box



















↳ Mechanical Elements



ITEM	NAME	TYPE	S	M	L
	Angle Bracket B-type 6060	-		8	
	AMB Spindle Support	160mm		1	
	Cable Sleeve	165mm		2	
	Coupler	6,35/8mm		1	
	Stop Ring	8mm		2	
	T8 Lead screw	250mm		1	
	Anti Backlash Nut	8mm		1	
	GT2 Pulley	20 teeth		3	
	Foot	M6x40		4	
	Ball bearing	8x22x7		2	
	Square Nut	M6		6	

	Cable Cover Cap	-	2
	GT2 Belts Tensor	Steel	6
	Wood Screws	3.5x25	4
	Cable Chain End Connector	Female	2
	Cable Chain End Connector	Male	2
	Cable tie	100 mm	15
	Sliding Nut	M4	12
	Sliding Nut	M6	67
	Spacer	M5x6	8
	Spacer	M5x9	8
	Spacer	M5x12	11
	Spacer	M5x15	5
	Spacer	M5x19	8
	Spacer	M5x30	13
	Spacer	M6x90	4
	Eccentric Spacer	M5x6	17
	Wheels	M5x24	31

	<i>DIN9021 Washer</i>	<i>M6x18</i>	<i>33</i>
	<i>DIN125A Washer</i>	<i>M6x12</i>	<i>12</i>
	<i>DIN985 Locknut</i>	<i>M4</i>	<i>6</i>
	<i>DIN985 Locknut</i>	<i>M5</i>	<i>44</i>
	<i>DIN934 Nut</i>	<i>M6</i>	<i>4</i>
	<i>Screw ISO 7380</i>	<i>M3x10</i>	<i>8</i>
	<i>DIN912 Screw</i>	<i>M4x12</i>	<i>19</i>
	<i>DIN912 Screw</i>	<i>M4x25</i>	<i>1</i>
	<i>DIN912 Screw</i>	<i>M5x16</i>	<i>11</i>
	<i>DIN912 Screw</i>	<i>M5x35</i>	<i>11</i>
	<i>DIN912 Screw</i>	<i>M5x40</i>	<i>4</i>
	<i>DIN912 Screw</i>	<i>M5x45</i>	<i>13</i>
	<i>DIN912 Screw</i>	<i>M5x85</i>	<i>8</i>
	<i>DIN912 Screw</i>	<i>M6x10</i>	<i>15</i>
	<i>DIN912 Screw</i>	<i>M6x12</i>	<i>25</i>
	<i>DIN912 Screw</i>	<i>M6x16</i>	<i>66</i>
	<i>DIN912 Screw</i>	<i>M6x20</i>	<i>1</i>
	<i>Hex Key</i>	<i>2 mm</i>	<i>1</i>

	Hex Key	2,5 mm	1
	Hex Key	3 mm	1
	Hex Key	4 mm	1
	Hex Key	5 mm	1
	Hex Key	6 mm	1
	Spanner	7 mm	1
	Spanner	8 mm	1
	Spanner	10 mm	1
	Assembly gauge	Acrylic	1
	Bearing Support Open	Acrylic	2
	Bearing Support Closed	Acrylic	2
	Cable Chain Support Y1	Steel	1
	Cable Chain Support Y2	Steel	1
	Cable Chain Support X	Acrylic	1
	Sensor Support Y	Acrylic	2
	Protection Plate Z	Acrylic	1
	Control Interface Protection Plate	Acrylic	1
	Cable cover for I-type 6 Profile	300mm	2

KIT CONTENT









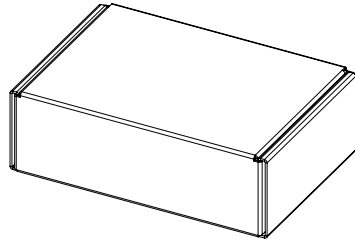

EVO

BOX 1/2

↳ Main box

↳ Electronic Components



ITEM	NAME	TYPE	S	M	L
	Stepper Motor	Nema 23		4	
	Motor Cable	XLR 4		4	
	GT2 Belt	930mm	3	1	/
	GT2 Belt	1330mm	/	2	3
	Mechanical Sensor SPDT	NC		4	
	Sensor Cable	XLR 3		4	
	Probing Device	-		1	
	Emergency Stop Button	-		1	
	Power Supply Cable	2m		1	
	USB Key	2Gb		1	

KIT CONTENT





EVO

BOX 1/2

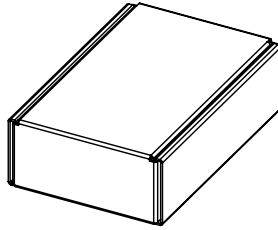
↳ Main box

↳ Spindle



ITEM	NAME	TYPE	S	M	L
	AMB Spindle	1050 FME-1		1	
	Power Supply Cable	4m		1	
	AMB Collet	8mm		1	
	Spanner	17mm		1	
	Flat End Mill	8mm		1	

OPTIONS - AMB SPINDLE FME-P 1400

	AMB Spindle	1400 FME-P		1	
	Spanner	25mm		1	
	ER16 Collet	8mm		1	

KIT CONTENT





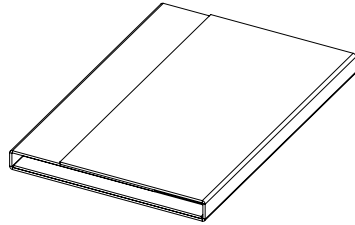

EVO

BOX 1/2

↳ Main box

↳ Specific Parts



ITEM	NAME	TYPE	S	M	L
	Foot	Steel		4	
	Gantry	Steel		2	
	X Carrier Front	Steel		1	
	X Carrier Back	Steel		1	
	Z1	Steel		1	
	Z2	Steel		1	
	AMB Spindle Support	Steel		2	









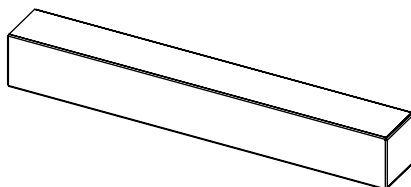

KIT CONTENT

EVO

BOX 2/2

↳ **Structural Elements**



ITEM	NAME	TYPE	S	M	L
	Aluminium Profile V-Type 3030	240 mm	2		
	Aluminium Profile I-Type 6030	770 mm	2	/	/
	Aluminium Profile I-Type 6030	1170 mm	/	2	3
	Aluminium Profile I-Type 6030	620 mm	2	2	/
	Aluminium Profile I-Type 6030	1020 mm	/	/	2
	Aluminium Profile V-Type 6060	830 mm	3	1	/
	Aluminium Profile V-Type 6060	1230 mm	/	2	3
	Cable Chain	500 mm	1	/	/
	Cable Chain	900 mm	1	2	1
	Cable Chain	1300 mm	/	/	1

GENERAL INFORMATION

CONTROL UNIT CONNECTION

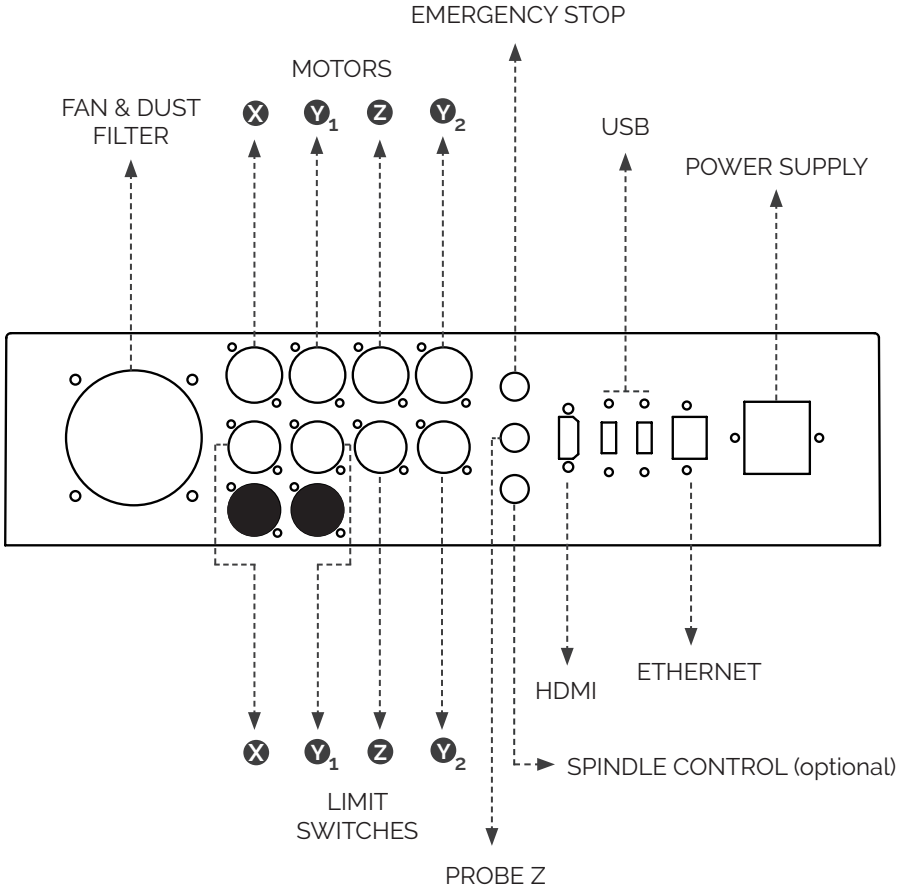

GENERAL INFORMATION

SPINDLE CONTROL (OPTIONAL)

If you have chosen the "controlled spindle" option (DI), please refer to the following documentation to install it correctly.

Pay attention that having a controlled spindle means that you have to indicate the rotation speed of the spindle in your CAM software (Fusion 360 or others)

1/ CONNECTION

1. Plug the GX12 4 pins connector into the control box as indicated.
2. Switch ON the button to allow the software to control the spindle

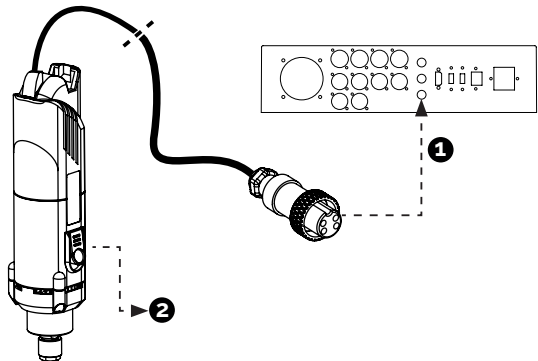

2/ SPINDLE CONTROL IN PLANETCNC

1. Click on this icon to manually switch ON and switch OFF the spindle



2. Click on this icon to modify the rotation speed in real time

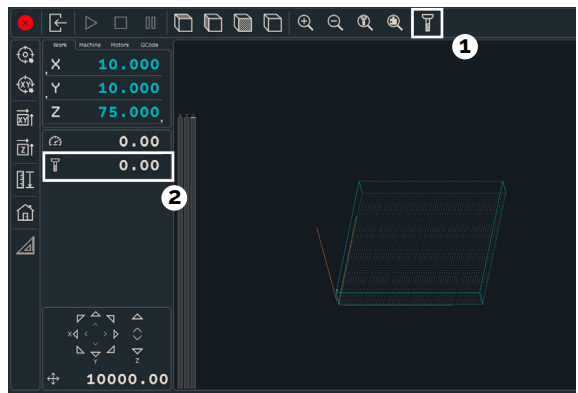





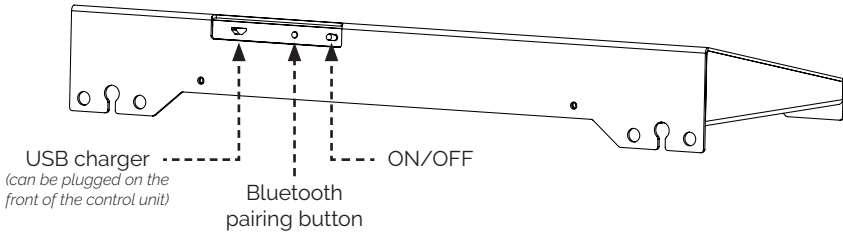
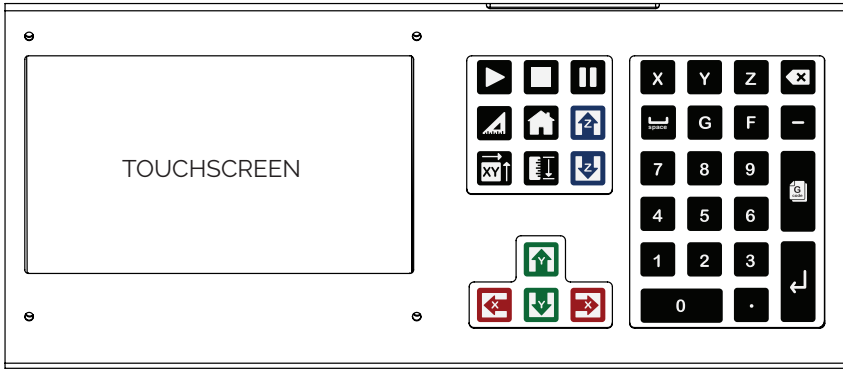











GENERAL INFORMATION

INTERFACE UNIT



KEYBOARD MAPPING

	Starts G-code		Moves Z+		Backspace
	Pauses G-code		Moves Z-		Opens Gcode file
	Stops G-code		Moves Y+		Space
	Triggers Square Gantry procedure		Moves Y-		
	Triggers Home procedure		Moves X+		
	Defines XY origin of the working coordinates		Moves X-		
	Triggers Probing procedure				

GENERAL INFORMATION

OTHER RESOURCES

1/ LEARN CAD-CAM SOFTWARE

If you don't use any specific CAD or CAM software yet, we suggest you to start with Fusion360. It's free to use for individuals, start-ups and schools, and there are many good learning resources online.

- Check it out here : <https://www.autodesk.com/products/fusion-360/overview>
- Access tutorials here (or on youtube) : <https://www.autodesk.com/products/fusion-360/learn-support>

2/ PLANET CNC RESOURCES

PlanetCNC has a fast growing community of users and a lot of learning resources.

- Access the official forum here : <https://www.cnczone.com/forums/planetcnc/>

3/ MEKANIKA RESOURCES

- Check out our series of tutorials and learn how to mill from scratch : <https://www.mekanika.io/r/cnc-tutorials>
- Read our articles about feeds & speeds, end mills, and many other subjects related to CNC milling : <https://www.mekanika.io/blog/learn-1>

